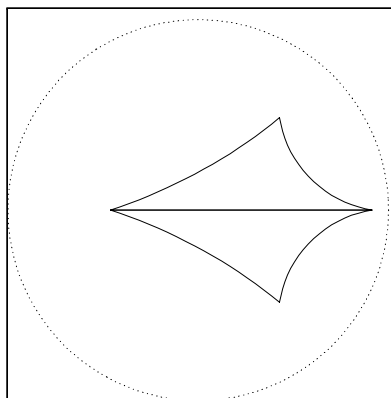
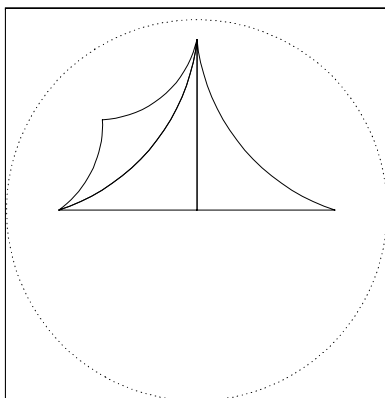

Table 6.5: Divisible quadrilaterals with free vertices



Case F1:  $K = 2$ ,  
 $(d, 2e, 2f) \subset (d, e, d, f)$



Case F2:  $K = 3$ ,  
 $(2, 2d, 3e) \subset (2, d, 2d, e)$

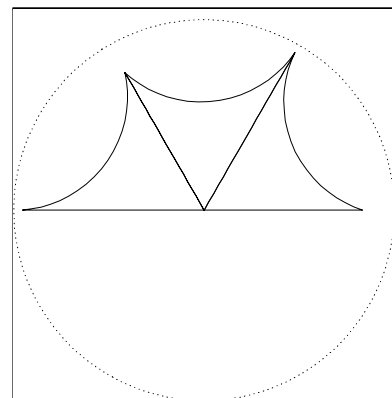

Case F3:  $K = 3$ ,  
 $(2d, 3, 2e) \subset (2d, 2e, d, e)$

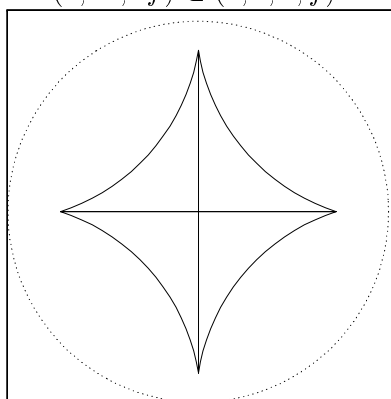

Case F4:  $K = 4$ ,  
 $(2d, 2e, 2) \subset (d, e, d, e)$

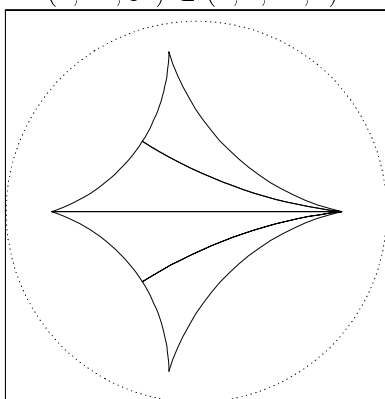

Case F5:  $K = 4$ ,  
 $(2d, 2, 4e) \subset (2d, d, 2d, e)$

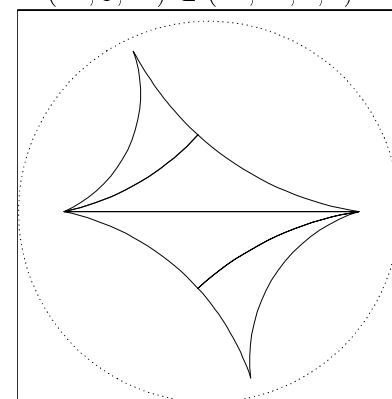

Case F6:  $K = 4$ ,  
 $(3d, 3e, 2) \subset (3d, e, 3e, d)$

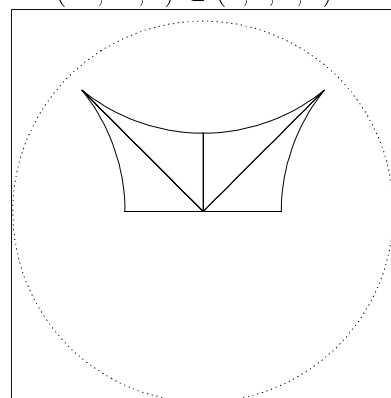

Case F7:  $K = 4$ ,  
 $(2, 4, 2d) \subset (2, 2, d, d)$

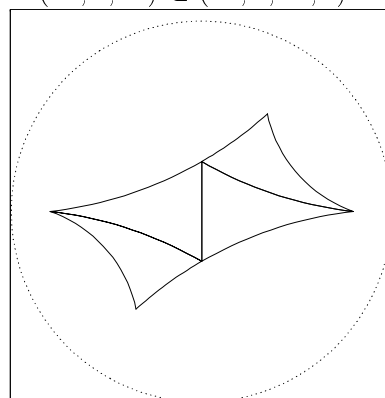

Case F8:  $K = 4$ ,  
 $(3, 3, 2d) \subset (3, d, 3, d)$

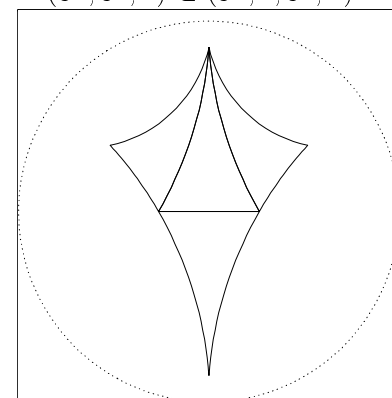

Case F9:  $K = 4$ ,  
 $(3, 3, 3d) \subset (3, 3d, 3, d)$

Table 6.5 - part 2

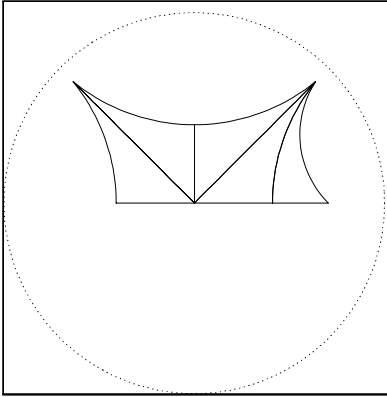

Case F10:  $K = 5$ ,  
 $(2, 4, 6d) \subset (2, 4, 2d, 3d)$

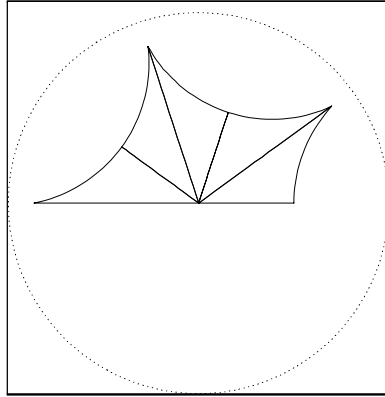

Case F11:  $K = 5$ ,  
 $(2, 2d, 5) \subset (2, d, d, 2d)$

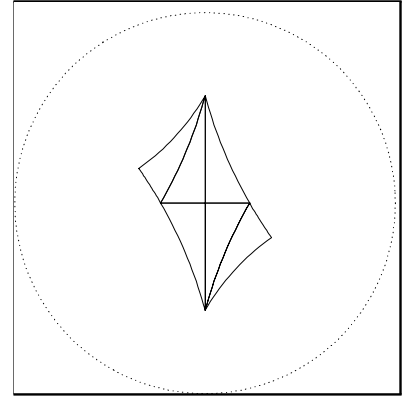

Case F12:  $K = 6$ ,  
 $(2, 3, 3d) \subset (2, d, 2, d)$

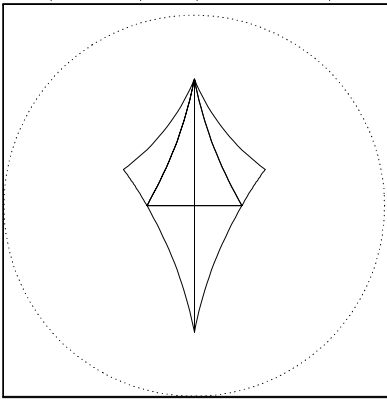

Case F13:  $K = 6$ ,  
 $(2, 3, 4d) \subset (2, 2d, 2, d)$

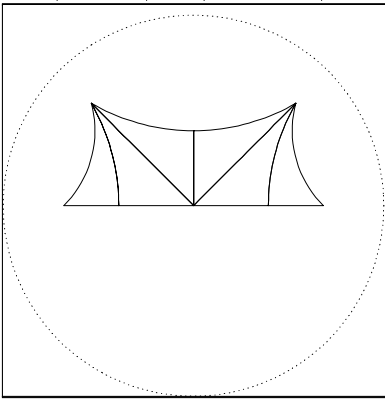

Case F14:  $K = 6$ ,  
 $(4, 2, 3d) \subset (4, 4, d, d)$

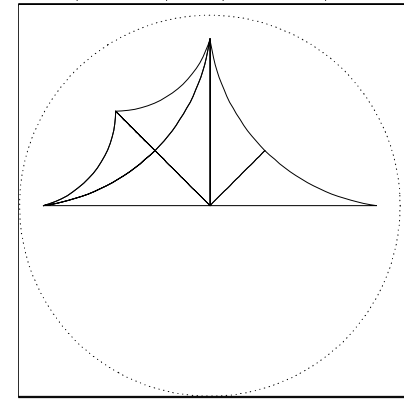

Case F15:  $K = 6$ ,  
 $(6d, 2, 4) \subset (6d, 2d, 2, 3d)$

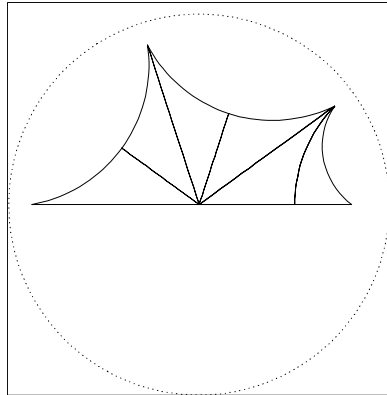

Case F16:  $K = 6$ ,  
 $(5, 6d, 2) \subset (5, 2d, 3d, 6d)$

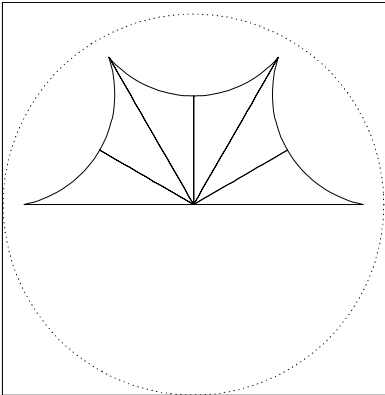

Case F17:  $K = 6$ ,  
 $(2d, 6, 2) \subset (2d, 2d, d, d)$

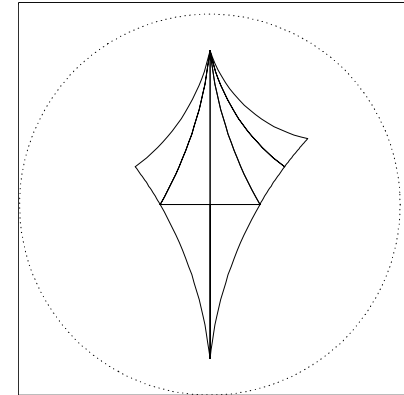

Case F18:  $K = 7$ ,  
 $(2, 3, 10d) \subset (2, 5d, 3, 2d)$

Table 6.5 - part 3

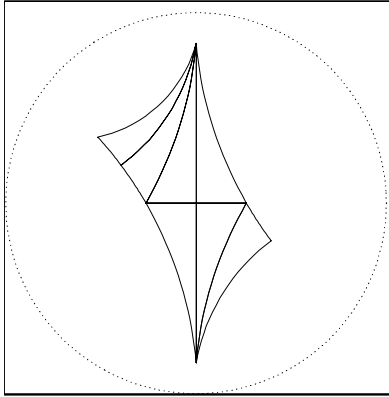

Case F19:  $K = 7$ ,  
 $(2, 3, 12d) \subset (2, 3d, 3, 4d)$

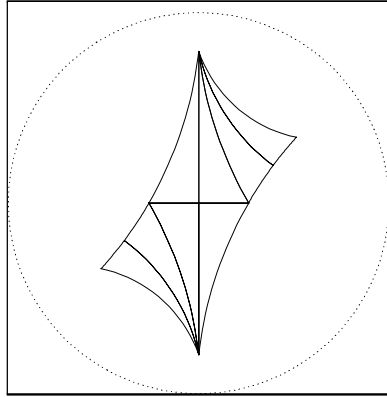

Case F20:  $K = 8$ ,  
 $(3, 4d, 2) \subset (3, d, 3, d)$

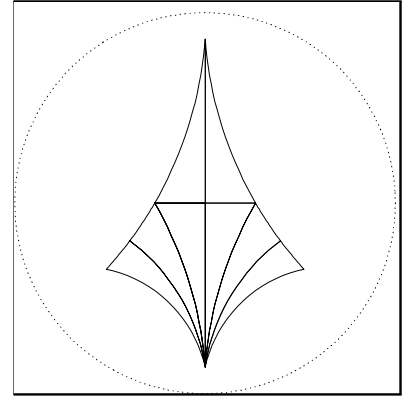

Case F21:  $K = 8$ ,  
 $(3, 6d, 2) \subset (3, d, 3, 3d)$

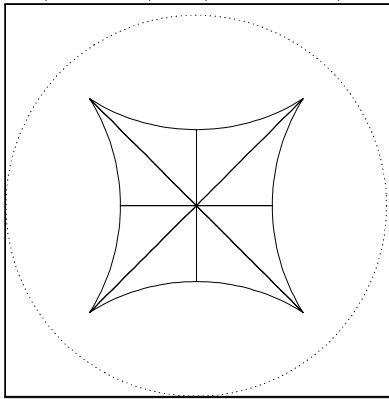

Case F22:  $K = 8$ ,  
 $(2d, 2, 4) \subset (d, d, d, d)$

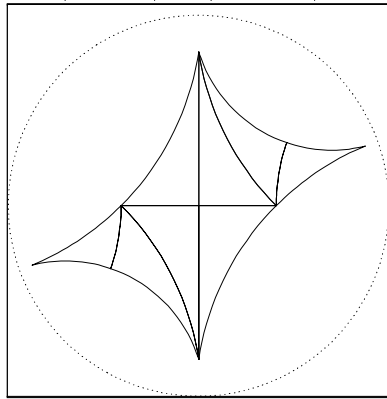

Case F23:  $K = 8$ ,  
 $(3d, 2, 4) \subset (3d, d, 3d, d)$

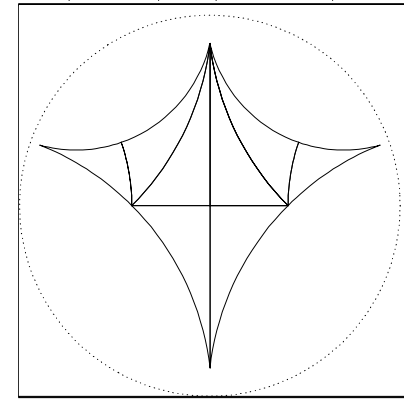

Case F24:  $K = 8$ ,  
 $(4d, 4, 2) \subset (4d, 2d, 4d, d)$

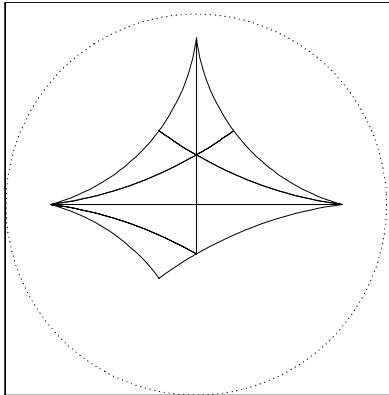

Case F25:  $K = 9$ ,  
 $(2, 3, 12d) \subset (2, 4d, 6d, 3d)$

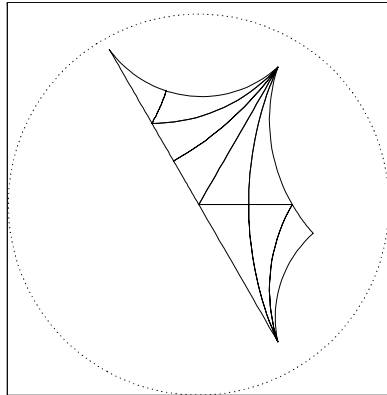

Case F26:  $K = 9$ ,  
 $(2, 3, 15d) \subset (2, 3d, 15d, 5d)$

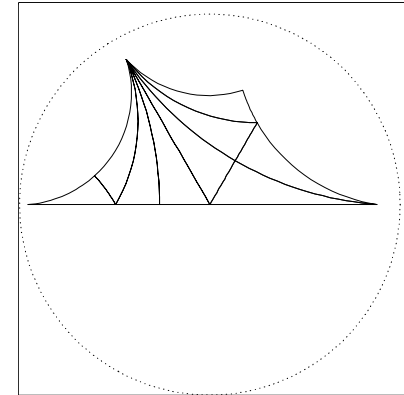

Case F27:  $K = 9$ ,  
 $(2, 6d, 3) \subset (2, d, 6d, 3d)$

Table 6.5 - part 4

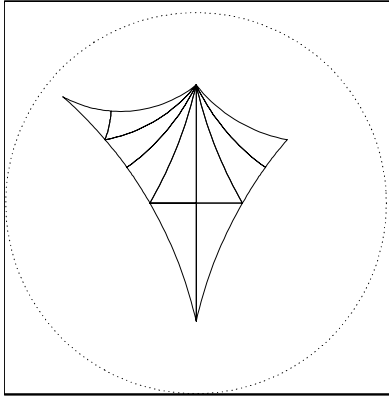

Case F28:  $K = 10$ ,  
 $(3, 14d, 2) \subset (3, 2d, 14d, 7d)$

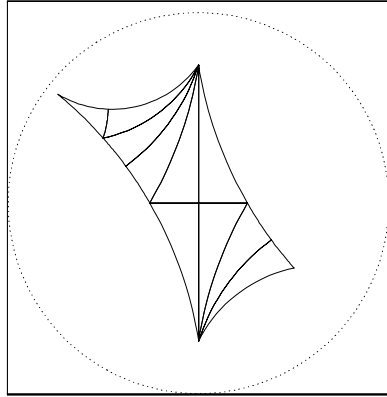

Case F29:  $K = 10$ ,  
 $(3, 2, 20d) \subset (3, 4d, 20d, 5d)$

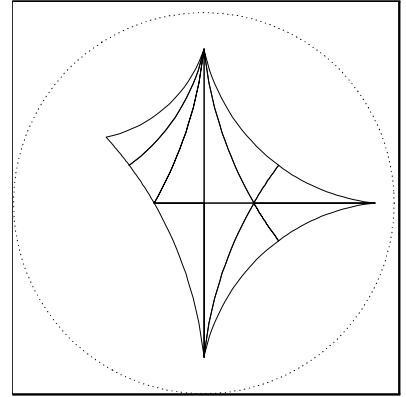

Case F30:  $K = 10$ ,  
 $(3, 2, 30d) \subset (3, 10d, 15d, 6d)$

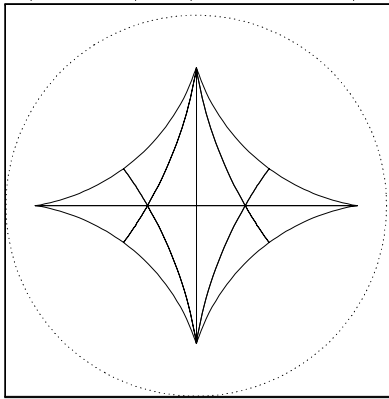

Case F31:  $K = 12$ ,  
 $(4d, 2, 3) \subset (2d, d, 2d, d)$

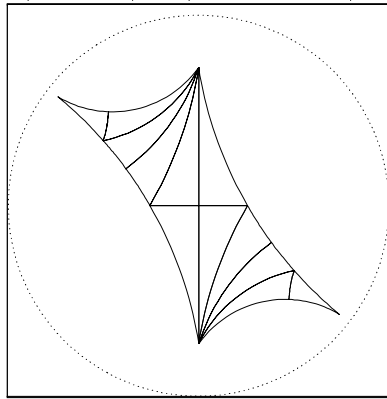

Case F32:  $K = 12$ ,  
 $(5d, 3, 2) \subset (5d, d, 5d, d)$

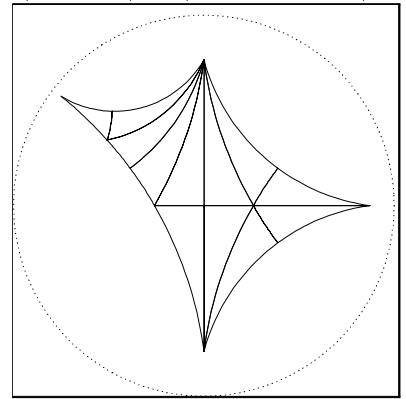

Case F33:  $K = 12$ ,  
 $(6d, 3, 2) \subset (6d, 2d, 3d, d)$

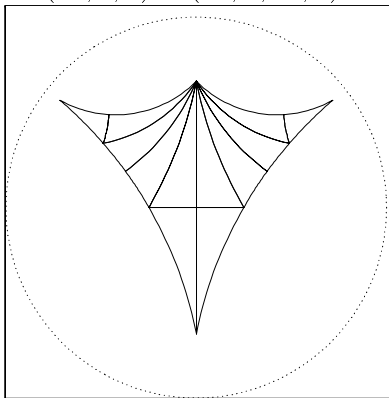

Case F34:  $K = 12$ ,  
 $(8d, 3, 2) \subset (8d, 4d, 8d, d)$